

KH-12 (300)

No	a*b	X
1	268x440	1
2	268x98	2
3	300x450	1
4	704x450	1
5	704x450	1
6	716x296	1
8	716x296	1

KH-12 (400)

No	a*b	X
1	368x440	1
2	368x98	2
3	400x450	1
4	704x450	1
5	704x450	1
6	716x396	1
8	716x396	1

KH-12 (500)

No	a*b	X
1	468x440	1
2	468x98	2
3	500x450	1
4	704x450	1
5	704x450	1
6	716x496	1
8	716x496	1

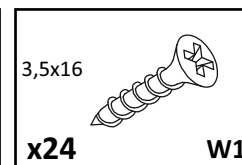
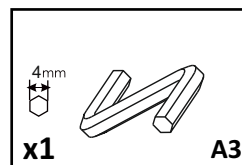
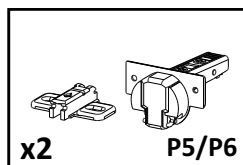
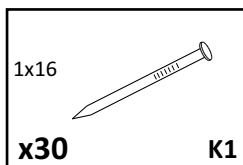
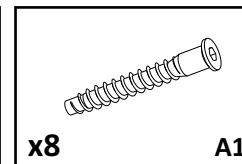
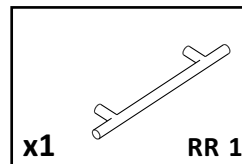
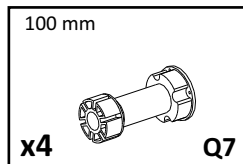
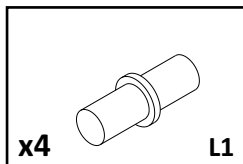

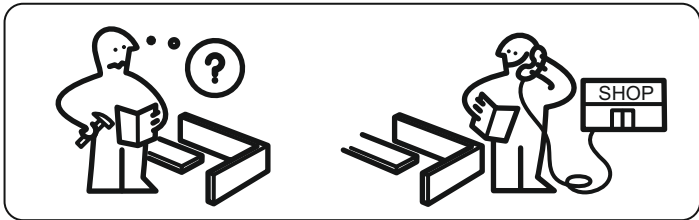
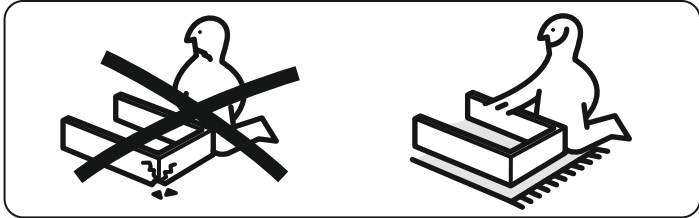
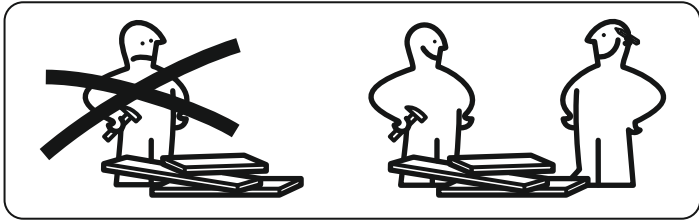

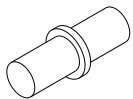
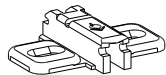
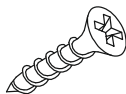
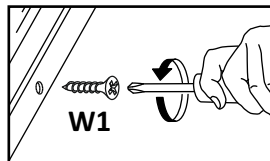
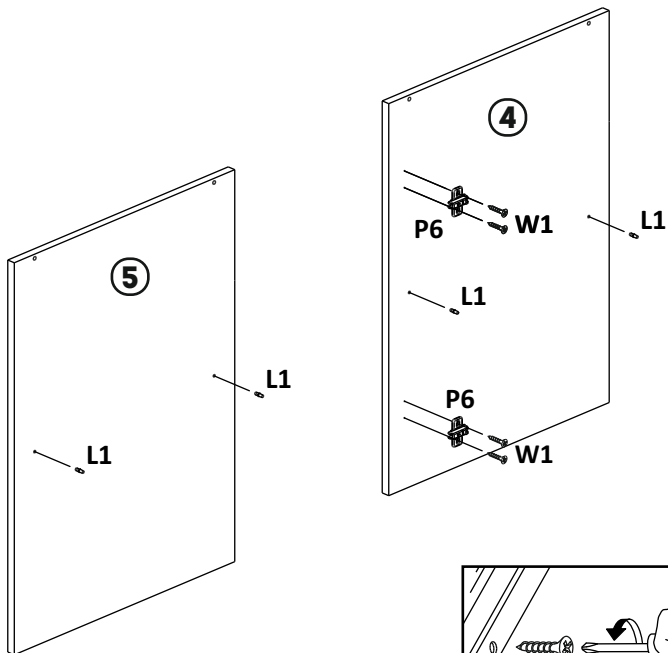
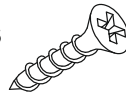
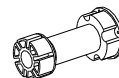
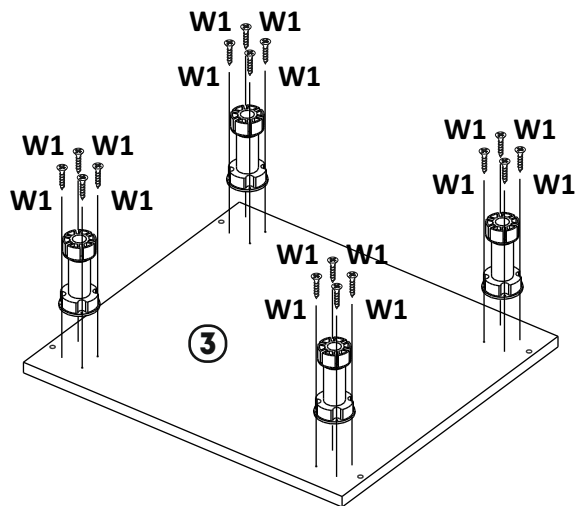
1**x4****L1****x2****P6****3,5x16****W1****x8****2****3,5x16****x16****W1****100 mm****x4****Q7**

3

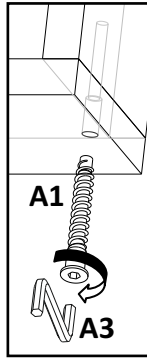
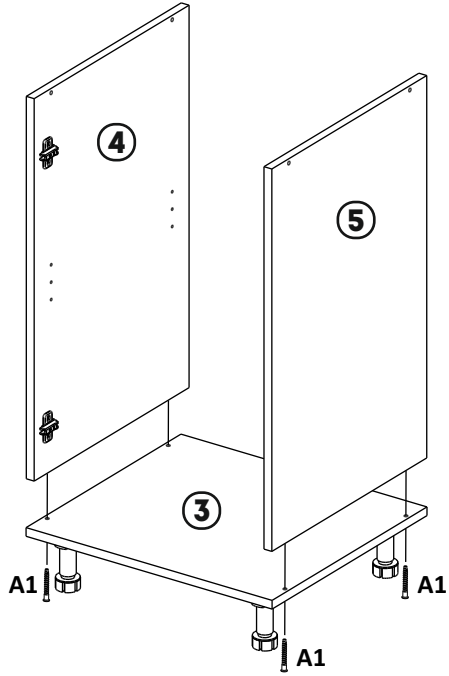
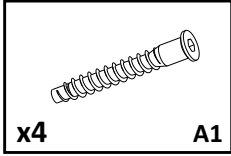

4

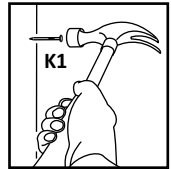
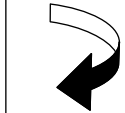
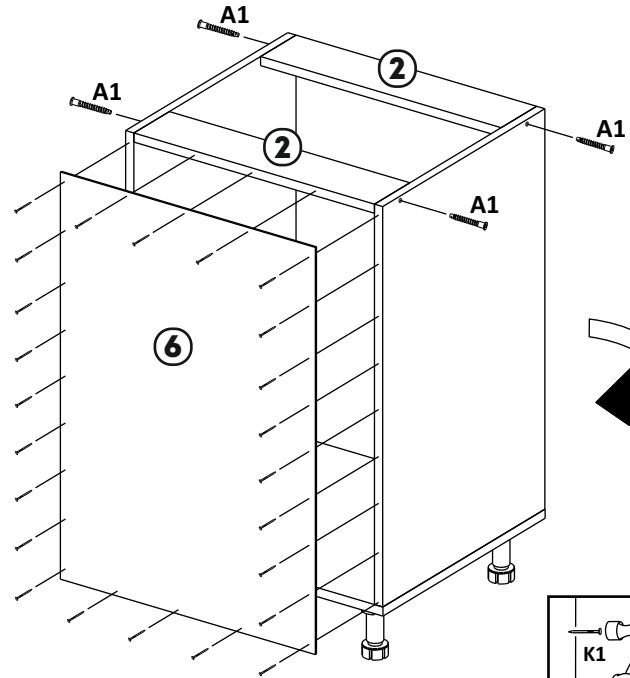
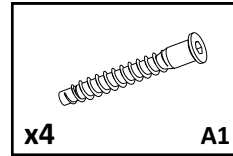
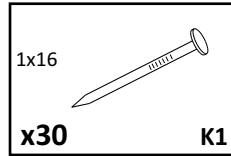

5

x1

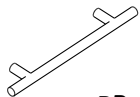

RR 1

x2

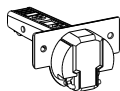

P5

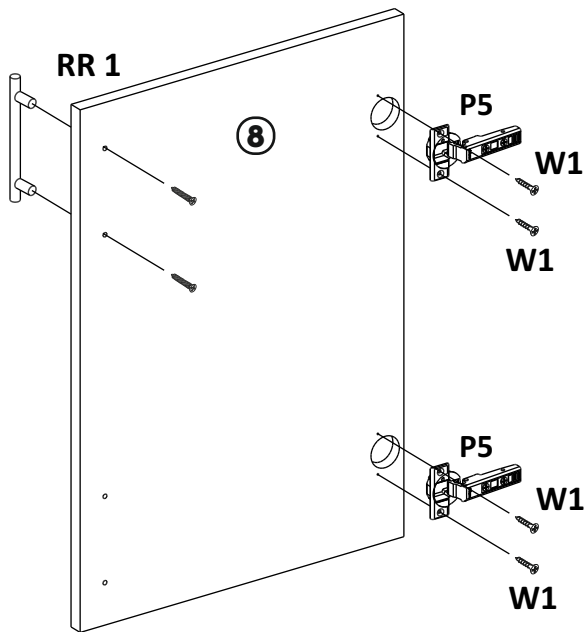
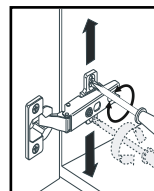
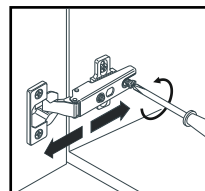
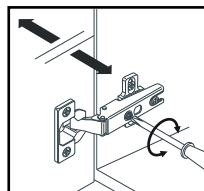
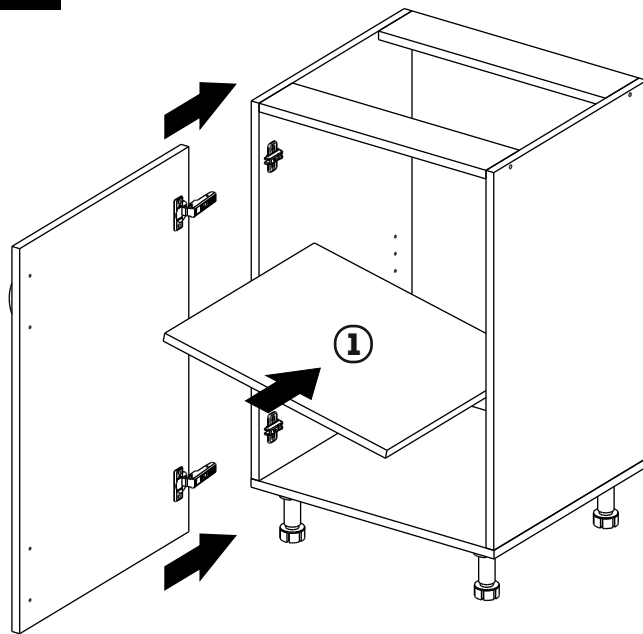
**6****7**